



Outdoor & Industrial  
Lighting designer and  
Manufacturer

2020-2021

PRODUCTS CATALOG

DongGuan Emilux Lighting Technology Ltd

Add:A-2F,XinYongShen tenology park,ShiLong Town,

DongGuan City,GuangDong Province,china

E-mail:sales@emiluxled.com

Http://www.emiluxled.com

## COMPANY INTRODUCTION

### Territory

- Specializing in LED lighting product sales, research and development and manufacturing as one of the high-tech enterprises;
- The company mainly produces high-power lights such as street lights, industrial and mining lights and high pole lights and some intelligent lighting products.
- Philips, China north, China steel and other well-known enterprises are our long-term cooperative customers.

### R&D

- Now we have a research and development team of more than 30 people. We can independently carry out ID industrial design and have more than 100 design patents with independent intellectual property rights.
- Product design won the German IF award, China lighting design award and other awards.

### Production

- We have a front-end R&D manufacturing factory in Shenzhen, and a large OEM customer manufacturing base in Hunan province, passed the ISO90001:2008 quality management system certification;
- With nearly 50 featured products, the production capacity exceeds 5000K sets/month, ensuring smooth supply.

### Service

- Develop brand product management policy based on customer's demand;
- Driven by innovation and guided by the principle of integrity, we will continue to provide customers with cutting-edge, innovative and cost-effective lighting products to achieve mutual benefit and coordinated development!

## CERTIFICATE



# CONTENTS



## GARDEN LIGHTS

 AVATAR Garden Lights - 02

## LED STREETLIGHT

SUNMAO Street Light - 04

BLACKBERRY Street Light - 09

 BLACK SWORD Street Light - 13

 BLACK SHARK Street Light - 17

 BLACK BLADE Street Light - 17

 BLACK SOLAR FLARE Street Light - 17

 APOLLO Street Light - 17

SOLAR Street Light - 17



## LED HIGH BAY

BLACK SNOW LED High Bay - 21

LINEAR LED High Bay - 25

UFO LED High Bay - 29



## LED FLOOD LIGHT

BLACK MAMBA LED Flood Light - 31

SUNMAO LED Flood Light - 35

Small King Kong LED Floodlight - 37

# AVATAR GARDEN LIGHTS



IP66



## AVATAR Garden Light - Magic Mushroom

■ Black  
■ Silver gray

The soft light and perfect atmosphere can make people very relaxed and comfortable. Just like the new Avatar street light launched by Kinlights, it can be used in courtyard, outdoor bar, villa, path, park etc.

Avatar Garden Lights is a new product launched by Kinlights in June 2020. It can emit light in both directions (upward + downward). The CRI can reach Ra95, with softer light and more amazing design!

Patented design  
Softer light  
CRI up to Ra95

Optical parameters

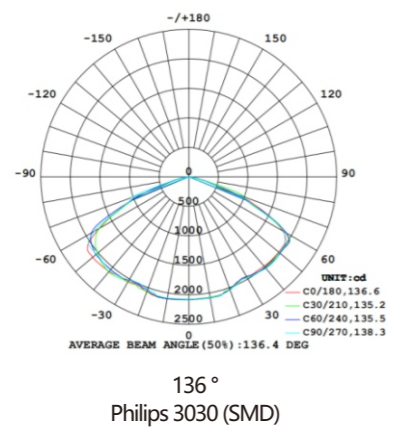
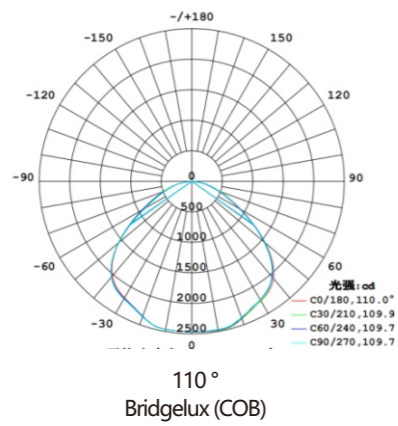

# SUNMAO Street Light



SUN  
MAO

## SUNMAO Street Light

IP66



## SUNMAO Street Light

■ Black  
■ Silver gray

1. 2018 The latest Patent design with compact and fashion appearance
2. Originate and Unique electronic connector design up to now, Easy for maintaining and replacement
3. IP66 Level protection.
4. Power from 60W up to 300W
5. Luminaire lighting efficacy 130Lm/w up to 160Lm/w
6. Patent design on straight pin led Modules. Easy assembly and maintainece
7. Long Lifespan
  - Good Heat Dissipation performance
  - Luminous SMD chips 3030 & 5050 available
  - Philips/Meanwell/Inventronics /Moso Driver available
8. Intelligetize design
  - Support installation difference intelligent controller inside
9. Customize your business
  - Laser Logo accept
  - Customized optical lens available
10. Beam angle of Lamp holder is adjustable



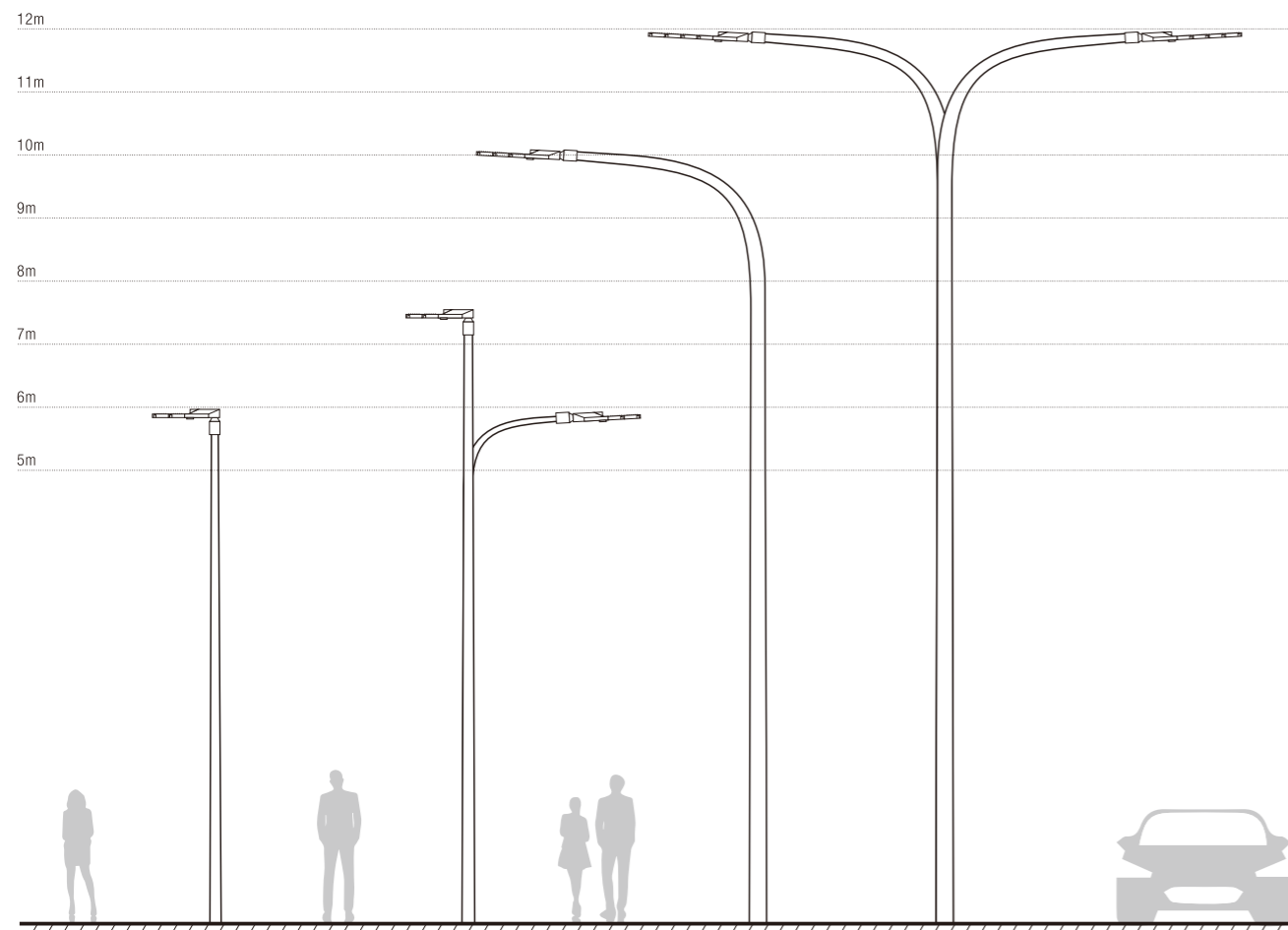

## Selection of pole height and wattage

| Height of pole | Distance between poles | Types of lanes | Traditional lamp | LED Street light |
|----------------|------------------------|----------------|------------------|------------------|
| 6 M            | 14-18 M                | Single lane    | 150W             | 65W              |
| 8 M            | 20-30 M                | Two lane       | 250W             | 120W             |
| 10 M           | 30-40 M                | Three lanes    | 300W             | 150W             |
| 12 M           | 40-50 M                | Four lanes     | 400W             | 200W             |
| 15M            | 50-60 M                | Four lanes     | 600W             | 250W             |

Intelligent  
High-efficiency  
Reliable

## Optical parameters



**Standardized joinable Module**  
Patent design on straight pin each module  
IP67 5 Year



**Patent Design**  
Easy to disassemble, easy to maintain.

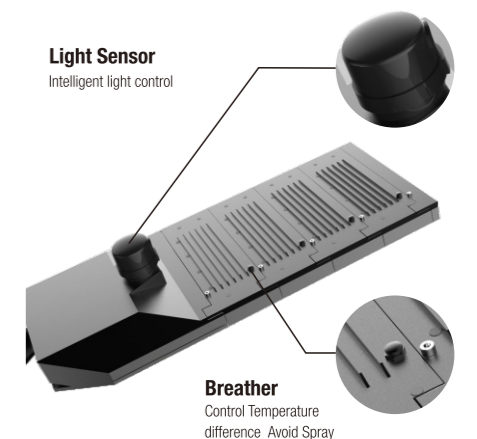

# BLACKBERRY Street Light



BLACK  
BERRY

IP66



## BLACKBERRY LED STREET LIGHT

1. 2019 The latest Patent design with compact and fashion appearance
2. Lightning Protection 10KV
3. IP67 Level protection.
4. Power from 30W up to 250W
5. Luminaire lighting efficacy 130Lm/w up to 160Lm/w
6. It can add light sensor
7. Various kinds of bad weather can be guaranteed for 5 years
8. Adjustable angle
9. Can be wall mounted

Black

Silver gray



# BLACKBERRY Street Light

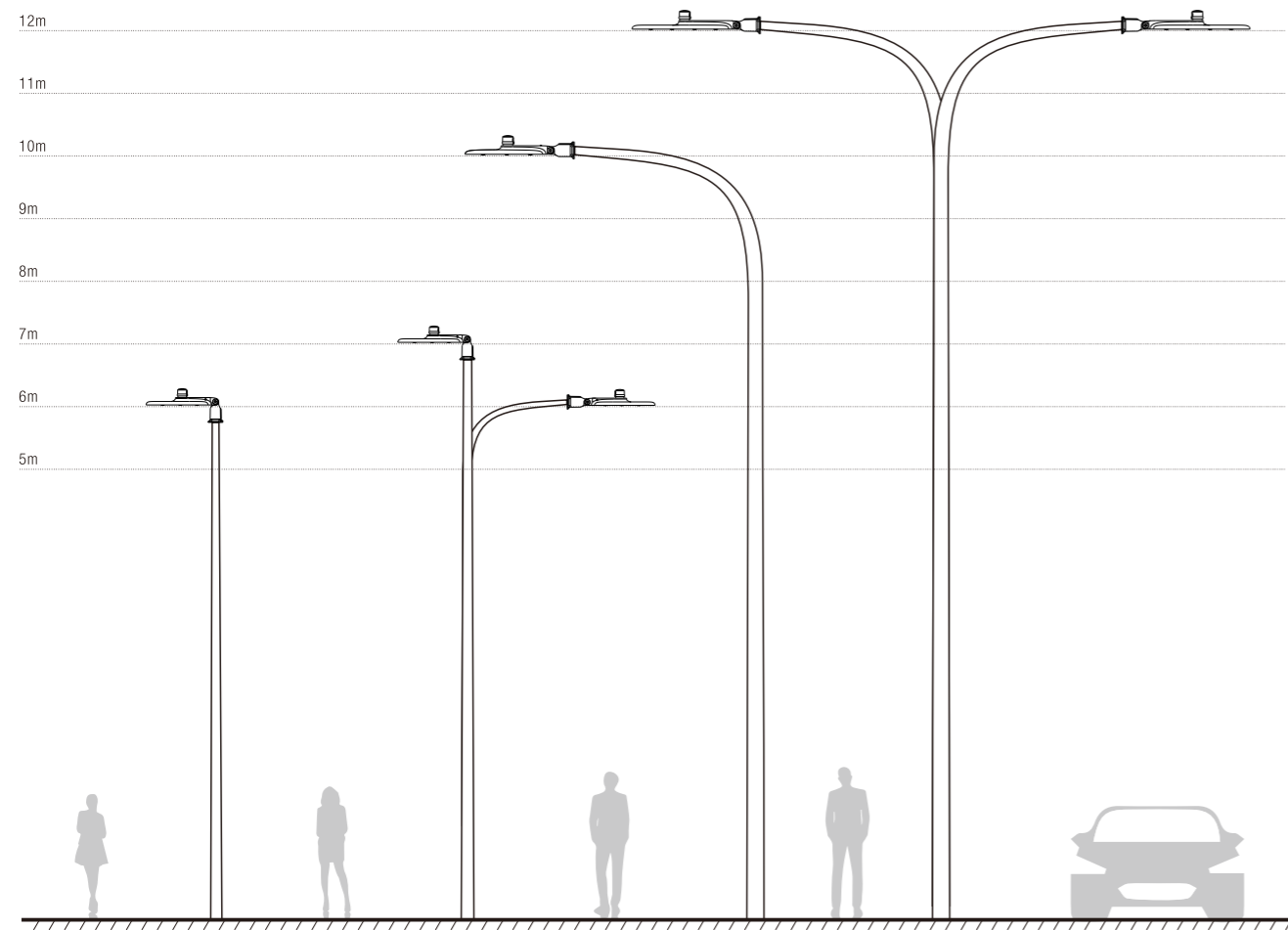

## Selection of pole height and wattage

| Height of pole | Distance between poles | Types of lanes | Traditional lamp | LED Street light |
|----------------|------------------------|----------------|------------------|------------------|
| 6 M            | 14-18 M                | Single lane    | 150W             | 65W              |
| 8 M            | 20-30 M                | Two lane       | 250W             | 120W             |
| 10 M           | 30-40 M                | Three lanes    | 300W             | 150W             |
| 12 M           | 40-50 M                | Four lanes     | 400W             | 200W             |
| 15M            | 50-60 M                | Four lanes     | 600W             | 250W             |

Intelligent  
High-efficiency  
Reliable

## Optical parameters

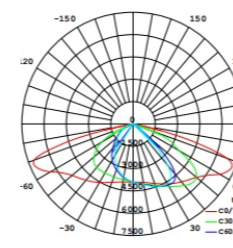

Type I-Medium

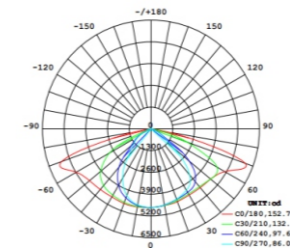

Type II-Medium

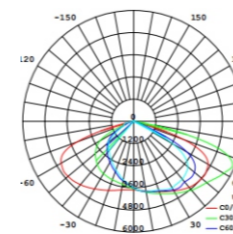

Type III-Short

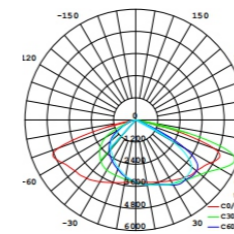

Type III-Medium

**Light Sensor**  
Intelligent light control



**Metal Nameplate**  
Improving Quality Sense



**Rotating Shaft**  
Compatible with two installation modes



**One-in-one mask**  
Black toughened glass





# BLACK SWORD Street LIGHT

IP66

new



## BLACK SWORD Street LIGHT

1. Large area lamp body, fast heat dissipation
2. High lumen efficiency, up to 170lm/W
3. Easy Maintenance
4. Tool-less open
5. Multiple Light Distribution
6. Power-off Protection
7. Detachable driver fixing plate
8. Self-cleanness

■ Black

■ Silver gray

# BLACK SWORD Street LIGHT

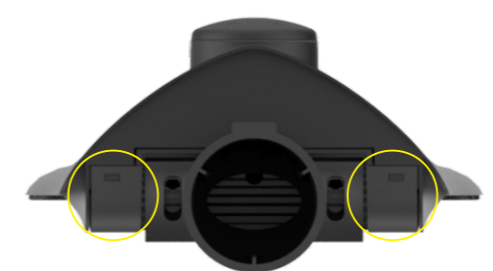
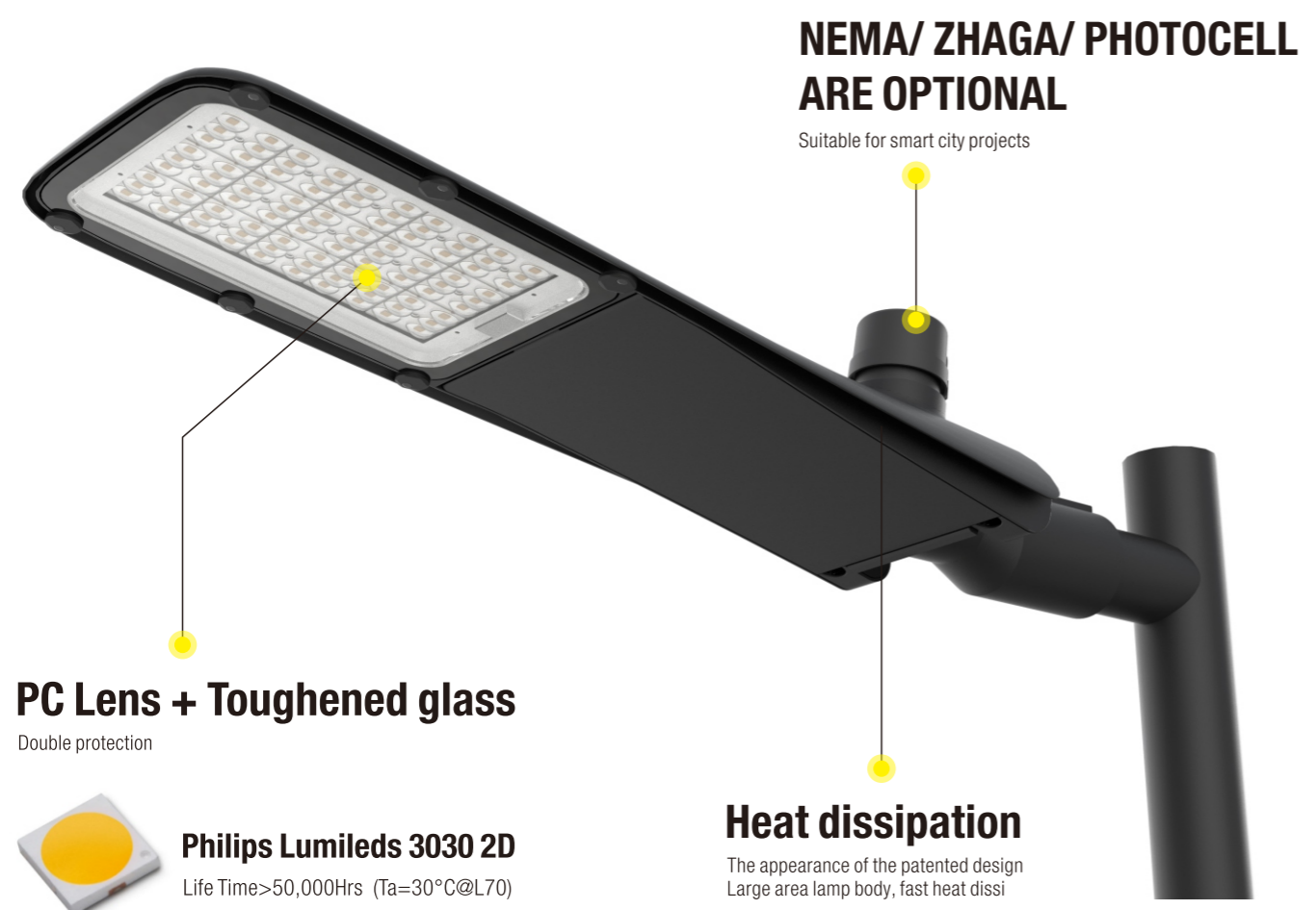

## Easy Maintenance tool-less open

Buckle for fixing heat sink could be opened without tools

## Optical parameters

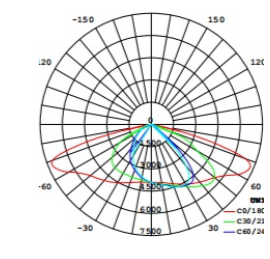

Type I-Medium

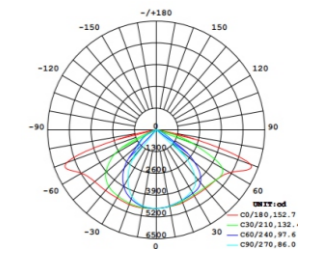

Type II-Medium

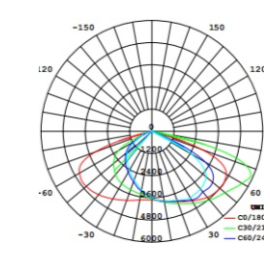

Type III-Short

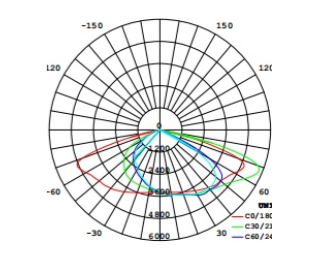

Type III-Medium



## Selection of pole height and wattage

| Height of pole | Distance between poles | Types of lanes | Traditional lamp | LED Street light |
|----------------|------------------------|----------------|------------------|------------------|
| 6 M            | 14-18 M                | Single lane    | 150W             | 65W              |
| 8 M            | 20-30 M                | Two lane       | 250W             | 120W             |
| 10 M           | 30-40 M                | Three lanes    | 300W             | 150W             |
| 12 M           | 40-50 M                | Four lanes     | 400W             | 200W             |
| 15M            | 50-60 M                | Four lanes     | 600W             | 250W             |



IP66

new



### BLACK SHARK Street LIGHT

- Black
- Silver gray

- 1. Economical, practical and cost-effective.
- 2. Independent drive box, high-performance LEDs, fast heat dissipation.
- 3. Up to 130lm/W

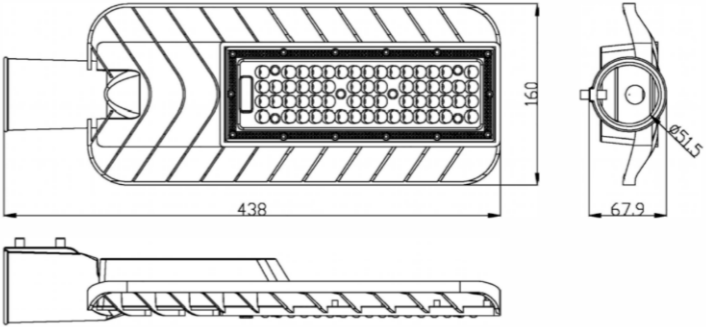

## Products parameter

|                                  |                  |             |             |
|----------------------------------|------------------|-------------|-------------|
| Model                            | SL-JL15-30W      | SL-JL15-50W | SL-JL15-60W |
| Power                            | 30W              | 50W         | 60W         |
| System Luminous flux             | 3600LM           | 6000LM      | 7200LM      |
| CCT                              | 4000K/5000K      |             |             |
| System efficiency (lm/W)         | 120LM/W          |             |             |
| Optics Target light distribution | T2M              |             |             |
| Optics Lens                      | PC               |             |             |
| Electric Input voltage           | 90-305V 50/60hz  |             |             |
| Electric Power factor            | ≥0.95            |             |             |
| Life span Light source life      | 30K Hours        |             |             |
| Life span Warranty period        | 3Years           |             |             |
| Operating temperature            | -40 ℃            |             |             |
| IP rate                          | IP65             |             |             |
| 90° IK rate                      | IK08             |             |             |
| Salt spray test                  | 500 hours        |             |             |
| Installation                     | Side insert 50MM |             |             |
| Mechanical Material & Finishing  | Aluminum/ black  |             |             |
| Minimum license                  | CE ROHS IK IP    |             |             |
| License/specification            |                  |             |             |
| Sustainability                   | ROHS             |             |             |

Intelligent  
High-efficiency  
Reliable

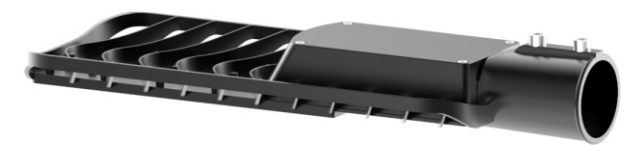
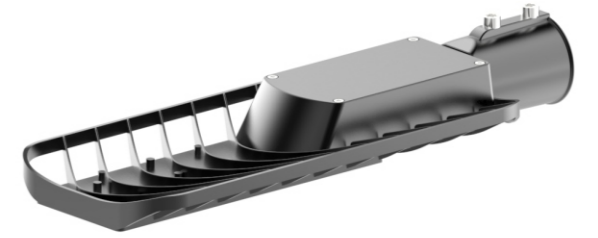

## Optical parameters

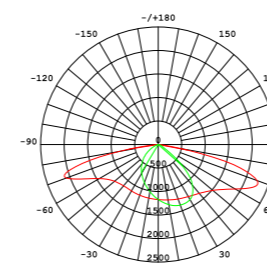

SL-JL15-30W

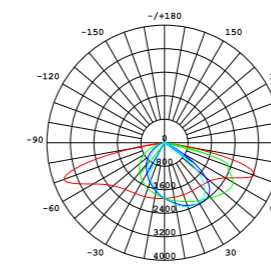

SL-JL15-50W

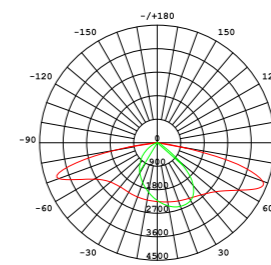

SL-JL15-60W



# BLACK BLADE Street LIGHT

IP66



## BLACK BLADE Street LIGHT

1. Economical, practical and cost-effective.
2. Independent drive box, high-performance LEDs, fast heat dissipation.
3. Up to 130lm/W

■ Black

■ Silver gray

# BLACK BLADE Street LIGHT

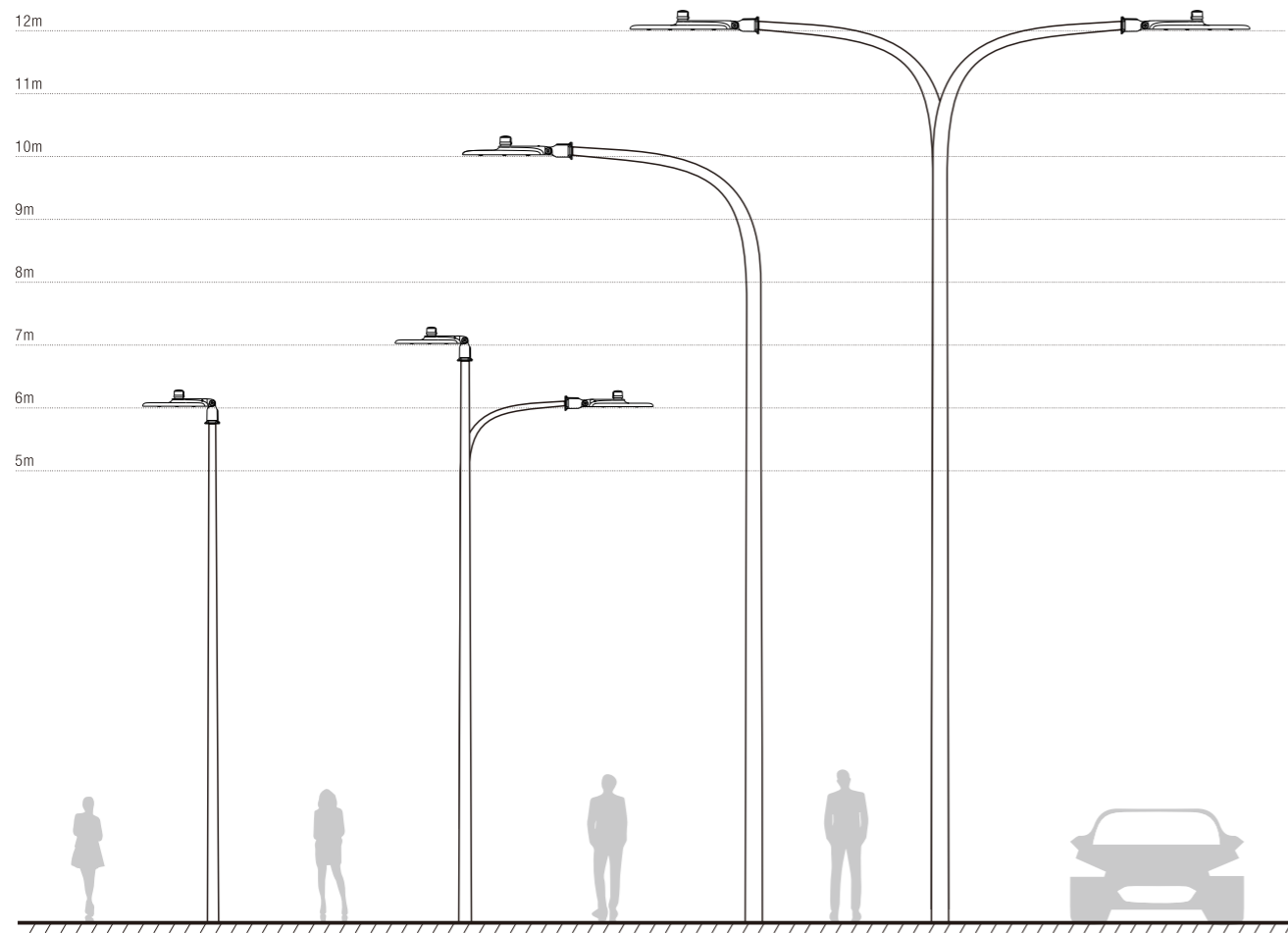

Intelligent  
High-efficiency  
Reliable



## Optical parameters

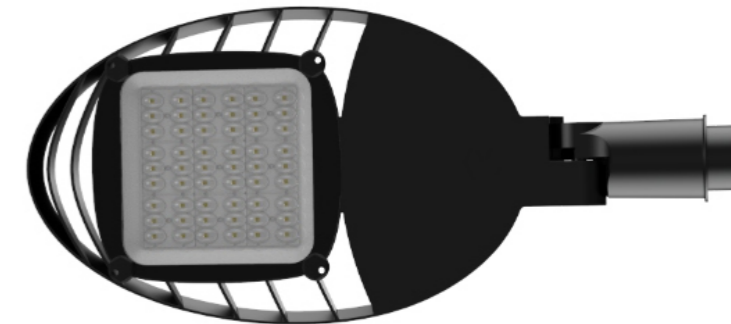
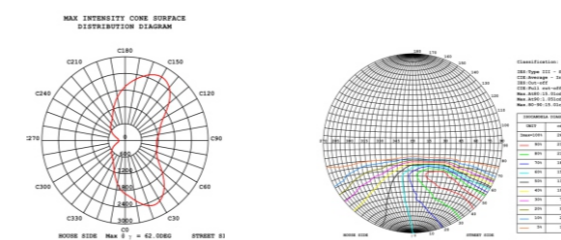
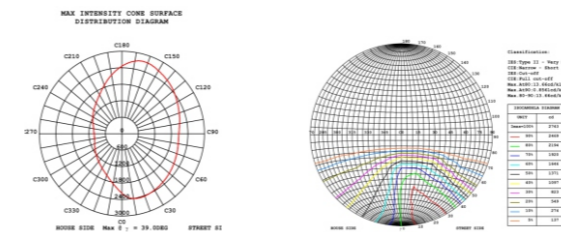
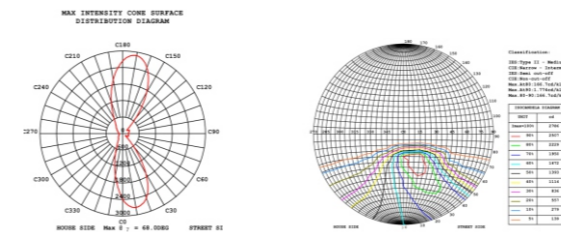

## Selection of pole height and wattage

| Height of pole | Distance between poles | Types of lanes | Traditional lamp | LED Street light |
|----------------|------------------------|----------------|------------------|------------------|
| 6 M            | 14-18 M                | Single lane    | 150W             | 65W              |
| 8 M            | 20-30 M                | Two lane       | 250W             | 120W             |
| 10 M           | 30-40 M                | Three lanes    | 300W             | 150W             |
| 12 M           | 40-50 M                | Four lanes     | 400W             | 200W             |
| 15M            | 50-60 M                | Four lanes     | 600W             | 250W             |



# MODULAR Street Light



IP65



## MODULAR Street Light

- Reduce wind resistance
- Large area lamp body, fast heat dissipation
- High lumen efficiency, up to 160lm/W
- Easy Maintenance
- Tool-less open
- Self-cleanness

- Black
- Silver gray

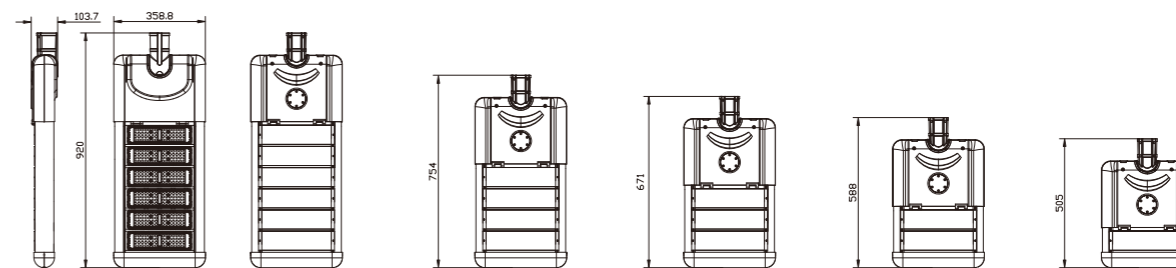

=



## Products parameter

| Model         | Power | Qty of models | CCT                           | CRI          | LPW        | Luminous flux | Beam angle            |
|---------------|-------|---------------|-------------------------------|--------------|------------|---------------|-----------------------|
| SL-SML01-30W  | 30W   | 1pcs          | 4000K/5000K<br>(for standard) | Ra70<br>Ra80 | 160lm/W±5% | 4800lm±5%     | ● T1-VS<br>(65°*135°) |
| SL-SML01-60W  | 60W   | 2pcs          |                               |              |            | 9600lm±5%     |                       |
| SL-SML01-90W  | 90W   | 3pcs          |                               |              |            | 14400lm±5%    |                       |
| SL-SML01-100W | 100W  | 3pcs          |                               |              |            | 16000lm±5%    |                       |
| SL-SML01-120W | 120W  | 4pcs          |                               |              |            | 19200lm±5%    | ● T2-L<br>(112°*166°) |
| SL-SML01-150W | 150W  | 4pcs          |                               |              |            | 24000lm±5%    |                       |
| SL-SML01-180W | 180W  | 5pcs          |                               |              |            | 28800lm±5%    |                       |
| SL-SML01-210W | 210W  | 6pcs          |                               |              |            | 33600lm±5%    |                       |

|                |              |                       |             |
|----------------|--------------|-----------------------|-------------|
| Housing colour | Black / Grey | Sleeve                | 60mm        |
| Materials      | AL+PC        | Input Voltage         | 90~305Vac   |
| Class Level    | Class I      | Storage Temperature   | -40~ +85°C  |
| IK             | IK08         | Operating Temperature | -40 ~ +80°C |
| IP             | IP65         | Surge protection      | 20KV        |

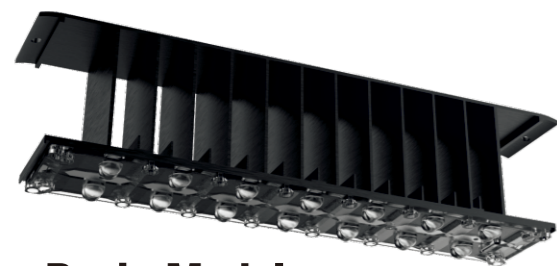

Basic Module

30W~210W

Up to  
6 modules

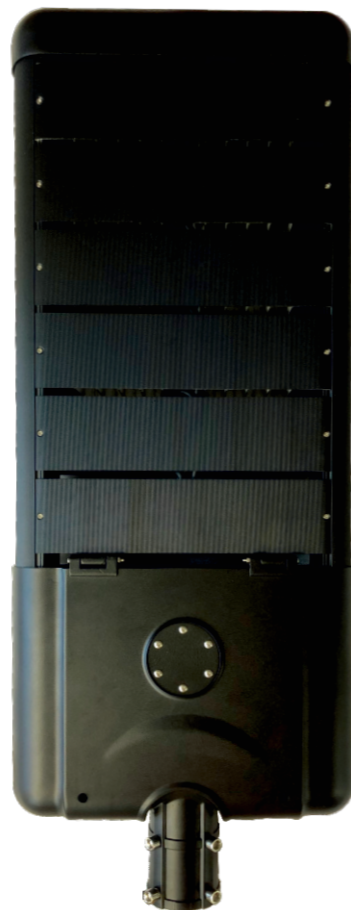

Practical  
widely used and durable

## Optical parameters

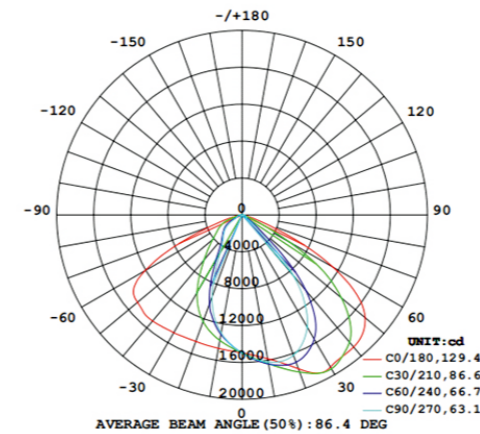

T1-VS (65°\*135°)

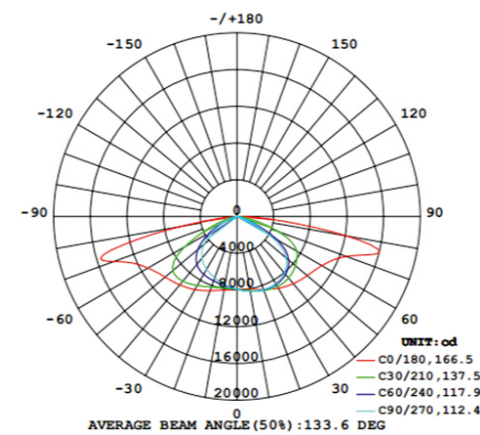

T2-L (112°\*166°)



Adjustable sleeve



Open driver box without tools

# SOLAR LED Street Light

IP66



## SOLAR LED STREET LIGHT

Black

Silver gray

1. The intergration of design ,no cable,the installation is very convenient.
2. The Mono-crystalline solar panel,LED lights,lithium battery,intelligent controller integrated Aluminum Alloy shell.
3. It used of lithium iron phosphate battery,fight the high temperature,keep long life.
4. When the products with optically controlled microwave induction infrared sensor, automatic adjustment of intelligent power on rainy days, extend rainy days.
5. It used of alloy material as the main structure,with good rust prevention,corrosion protection.
6. The wireless remote control setting device,adjustable lighting time,lighting power ,automaticdetection of battery voltage,read light power parameters,a human body induction function,aslong as people go through when full power lighting,no automatic power down alf, restoreenergy saving mode.
7. time control + light sensor control+ motion sensor control
8. Motion and light sensor built in:solar street light goes on at dusk at 50% brightness.  
Can gofrom 50% power to full brightness when motion is detected. Three Intelligent Modes: Bright /DIM / Recharge.  
1. Bright: motion activates for lighting when motion is detected for securitylight and to save battery;  
2. DIM: 50% lighting for saving power when no motion;  
3. Off/Recharge: automatically turns off in daylight and goes into recharge mode. (workingmode can be adjusted according to client's demands)

S-SOLAR

## SOLAR LED Street Light

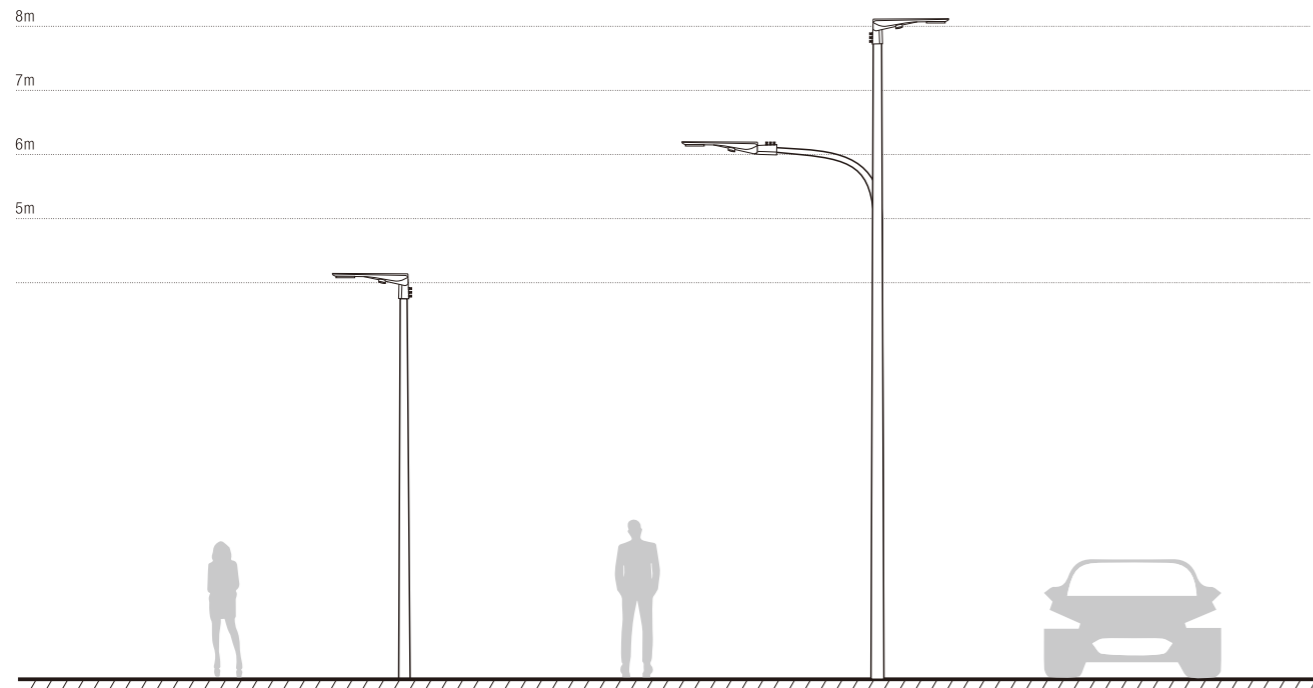

Intelligent  
High-efficiency  
Reliable

**Solar panel**  
30W /18V monocrystalline silicon



**Microwave sensor**  
Ensure the effective lighting



## Selection of pole height and wattage

| Model                     | Solar LED Street Light SL-JLTY-20W / 30W / 50W                           |   |
|---------------------------|--|---|
| Battery                   | 18650 lithium battery 12V 20 Ah  | 18650 lithium battery 12V 20 Ah                 |
| Beam angle                | 150x70°  | 150x70°   |
| Pole diameter             | 60MM   | 60MM  |
| Light output              | 20W  | 30W   |
| Luminous flux(lm)         | 2100   | 3200  |
| Chip Brand                | LUXEON 5050  | LUXEON 5050                                     |
| Solar panel               | 30W /18V monocrystalline silicon   | 30W /18V monocrystalline silicon                |
| CRI                       | > 80   | > 80  |
| Color Temperature         | Warm white:2700-3200K / Neutral white:4000-4500K / Pure white:5000-6500K |   |
| Operating time            | Full power >12 hours ,Intelligent mode 3-4 days                          | Full power >12 hours ,Intelligent mode 3-4 days |
| Control Mode              | Light Control + Sensor   | Light Control + Sensor                          |
| Luminous efficiency(lm/w) | >100   | >100  |
| Lifespan(hrs)             | >50000   | >50000  |

## Optical parameters

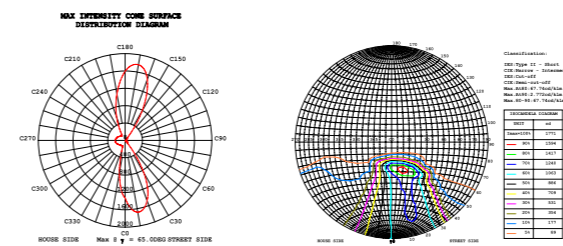

20W Solar LED Street Light IES

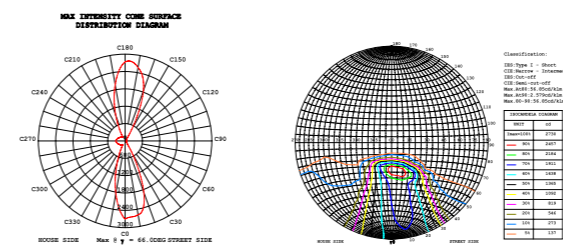

30W Solar LED Street Light IES



**Intelligent control system**  
Without human body induction at night



**Intelligent control system**  
With human body induction at night

# BLACK SNOW LED high bay



IP66

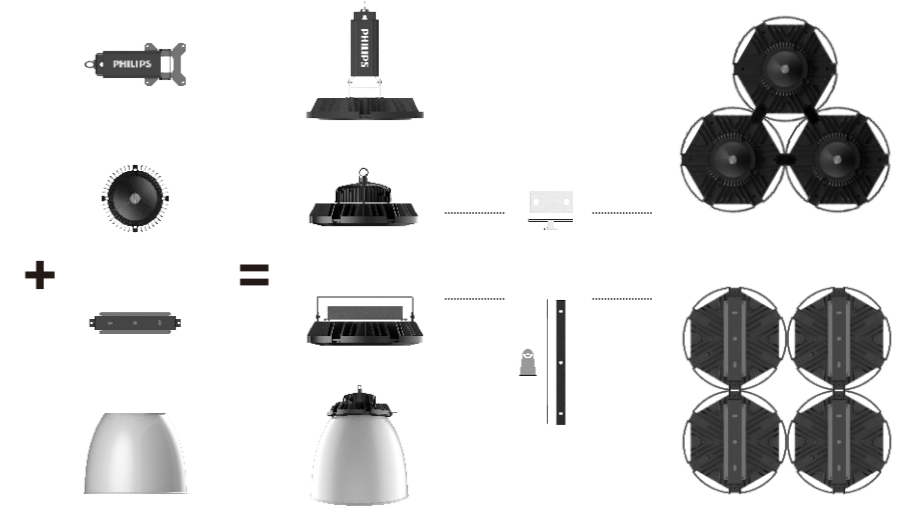

Only **↓ 2.5KG**    Up to **↑ 200W**  
100W-200W

## Customers Oriented Standardization design

1. Compact and fashion design
2. Patent structure and appearance
  - Foldable power supply
  - Cost down for packaging and transportation
  - Honeycomb inspiration
  - Heat dissipation efficiency up to 30%
3. Standardization design
  - Quick and easy replacement spare parts
4. Modularization design
  - Reduce the stocks , up-to-power 1500 W by assembly
  - Quick and easy installation
  - Quick and easy maintenance
5. Long lifespan
  - Good heat dissipation performance
  - LUMILEDS SMD Chips 3030 & 5050
  - PHILIPS power supply
6. Environmentally
  - Support microwave sensor for energy saving
7. Customize your business
  - Silk screen Logo plate available
  - Customized optical lens available
8. Installation methods: hook ring, bracket, tube. match with both rectangle and round power supply
9. Protection grade reaches IP66 for the applications of indoor and outdoor

**BLACK  
SNOW**



**BLACK SNOW LED high bay**

**Modularization**

- LUMILEDS SMD chips with high luminous efficacy
- High efficiency PHILIPS power supply
- Appearance and structure patent

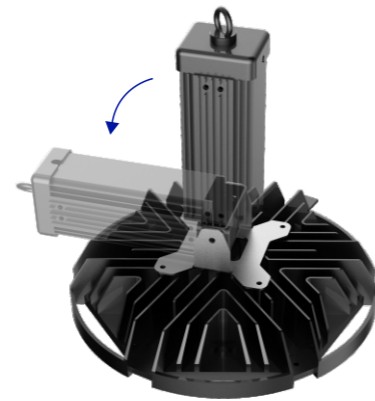

**Foldable Power supply**

Customers Oriented Standardization design



Round power supply Meanwell



Rectangle power supply Meanwell



PHILIPS Power supply



Reflector

**Optical parameters**

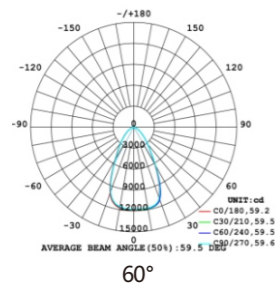

**Modularization Assembly**  
Up-to-power 1500W  
Round power supply

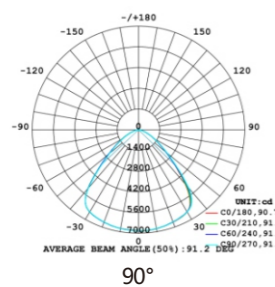

**Modularization Assembly**  
Up- to-power 1500W  
Rectangle power supply

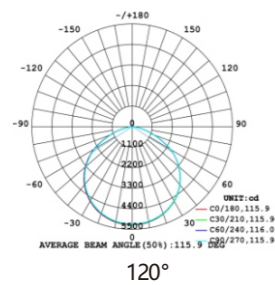

**Beam Angle**

Beam Angle : 15° 60° 90° 120° Optional

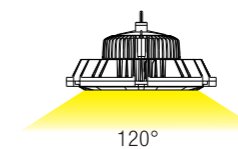
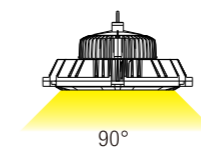
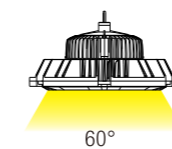

**Application**

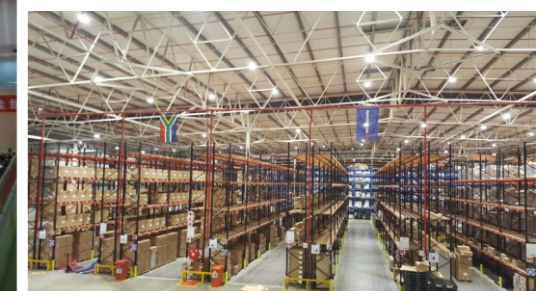
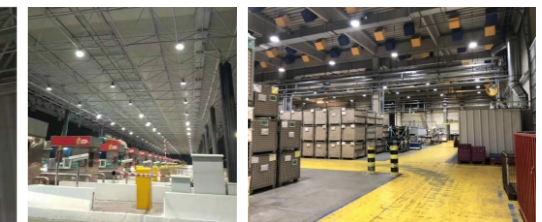

# LINEAR LED High Bay



LINEAR  
LED HIGH BAY

IP66 / IK08



## LINEAR LED High Bay

Black

1. High protection level, safe and reliable: IP65, IK08
2. The movable connecting rod design can be compatible with horizontal and vertical lamp pole installation, and can adjust the light-emitting angle to meet the optical design requirements of various road conditions.
3. Integrative structure heat dissipation, smooth rib-free design on the back of lamps to avoid dust accumulation, effectively ensure the normal use of lamps at high temperature
4. Heat dissipation design corresponding to LED light source one by one, avoiding heat effect between light sources is more conducive to rapid heat conduction and heat dissipation.
5. Optical systems can be selected to meet various road optical requirements.

Easy to assemble  
and durable

## Products parameter

|                    |                                  |  |
|--------------------|----------------------------------|--|
| <b>System</b>      | <b>Power (+/-10%)</b>            | 80W / 100W / 150W / 200W / 300W / 400W |
|                    | <b>Luminous flux</b>             | 10400LM~52000LM                        |
|                    | <b>CCT</b>                       | 4000K/5000K                            |
|                    | <b>System efficiency (lm/W)</b>  | 130LM                                  |
| <b>Optics</b>      | <b>Target light distribution</b> | 120°                                   |
|                    | <b>Lens</b>                      | PC                                     |
| <b>Electric</b>    | <b>Input voltage</b>             | 100-277V 50/60hz                       |
|                    | <b>Power factory</b>             | ≥0.95                                  |
|                    | <b>Overload protection</b>       | Can change 6KV                         |
| <b>Lifespan</b>    | <b>Light source life</b>         | 50K Hours                              |
|                    | <b>Warranty period</b>           | 5Years                                 |
| <b>Environment</b> | <b>Operating temperature</b>     | -40°C+70°C                             |
|                    | <b>IP rate</b>                   | IP65                                   |
|                    | <b>IK rate</b>                   | IK08                                   |
|                    | <b>Salt spray test</b>           | 500 hours                              |
|                    | <b>Installation</b>              | Side insert 60MM                       |
| <b>Mechanical</b>  | <b>Material &amp; Finishing</b>  | Aluminum/silver, black                 |
|                    | <b>Minimum license</b>           | CE ROHS IK IP                          |

## Installation method

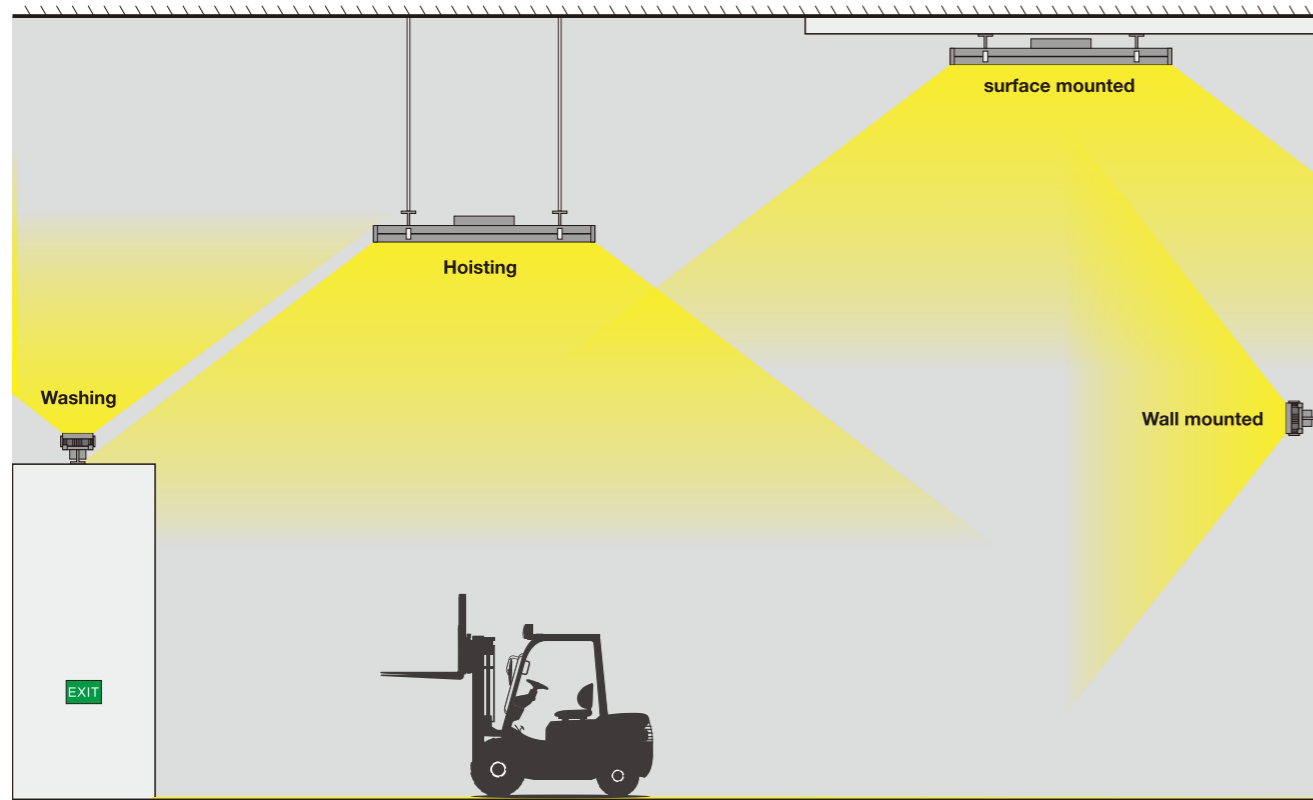

## Optical parameters

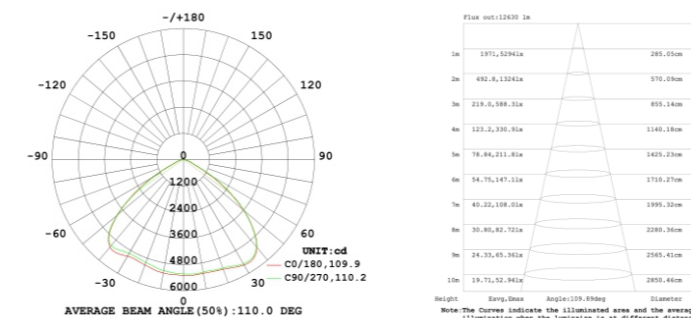

# UFO LED High Bay

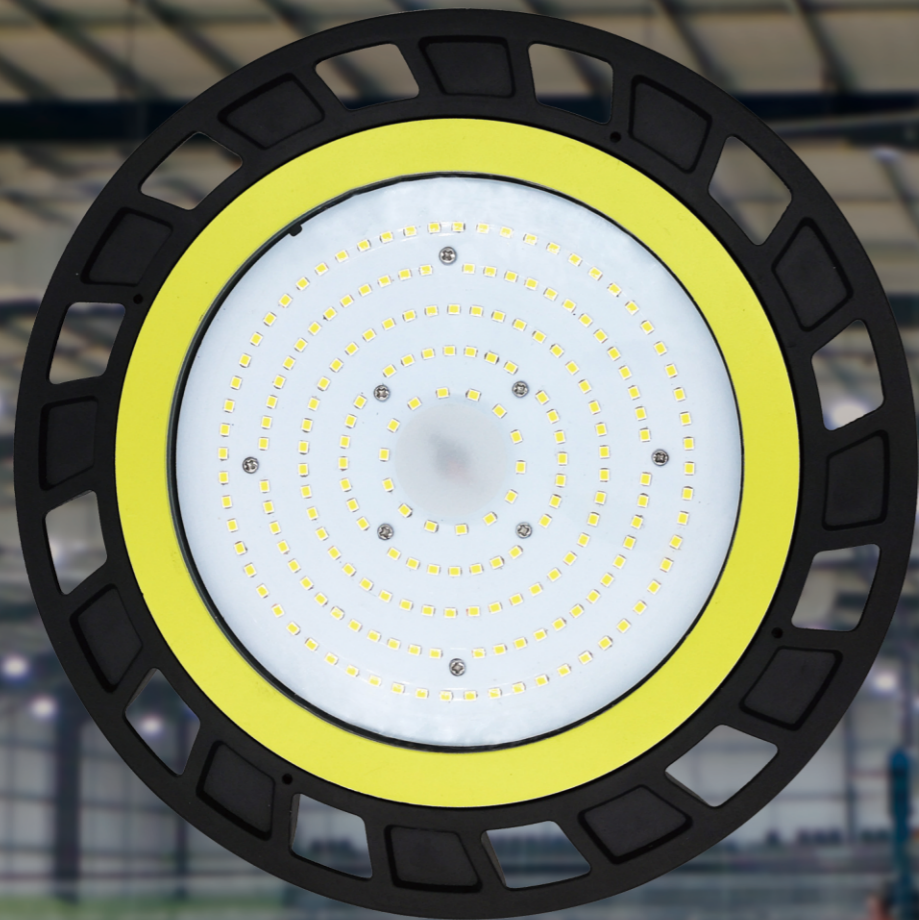

IP65



## UFO LED High Bay

1. Using cold forging process molding, bigger radiating area, better radiating effect.
2. High stability and color rendering
3. Old brand with quality assurance
4. IP level is high, the protective effect is better
5. Ring Bead color diversification, with a variety of selectivity
6. Non flicker, Non dazzling, High brightness.
7. Charming quality and design ,long life span
8. 3~5 years warranty (optional)



Black

## Optical parameters

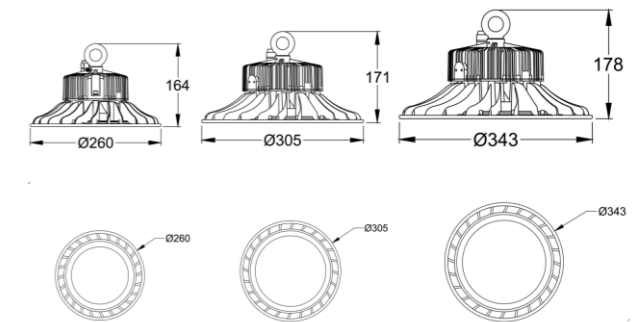
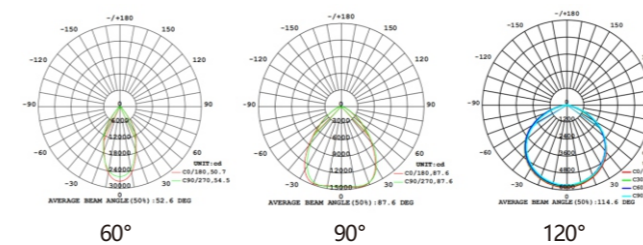

## Products parameter

|                                  |  |
|----------------------------------|--|
| <b>Product model / Power</b>     | HB-JL06-100W / HB-JL06-150W / HB-JL06-200W |
| <b>Input voltage</b>             | AC85V-265V                                 |
| <b>Frequency range</b>           | 50HZ-60HZ                                  |
| <b>Total harmonic distortion</b> | ≤20%                                       |
| <b>Lamp's efficiency</b>         | >94%                                       |
| <b>Color temperature</b>         | 3000k / 4000k~4500k / 5700k~6500k          |
| <b>LED Brand/Type</b>            | 2835 / 3030 LED                            |
| <b>LED luminous efficiency</b>   | 150LM/W                                    |
| <b>Working life-span</b>         | >50,000H                                   |
| <b>CRI</b>                       | ≥70  |



# BLACK MAMBA LED flood light



**BLACK MAMBA**

IP67



**Basic Module**

100~1200W



## Modularization elements flexible collocation

The Flood light is a truly unique, versatile, high powered and robust floodlight, offering countless configurations to achieve the uniform light coverage you require.

Boasting industry leading CREE chips and Meanwell drivers for ultimate reliability there's no other high mast solution like it on the market. Designed with passion, built with pride.

### PRODUCT ADVANTAGES

1. 270°rotation, no product waste and light pollution.
2. Improve air convection and reduce wind resistance.
3. Each module works independently and is convenient for maintenance and cost saving.
4. It can realize independent and rapid completion of bracket Angle adjustment.

### PRODUCT FEATURES

1. Simple Module Replacement.
2. A unique feature of the 200W & 300W vertical Black Mamba is it's ability to control the direction of each module.
3. 360°rotation, no product waste and light pollution.
4. Improve air convection and reduce wind resistance.
5. Each module works independently and is convenient for maintenance and cost saving.
6. It can realize independent and rapid completion of bracket Angle adjustment.
7. Suitable for any Application.

## Optical parameters

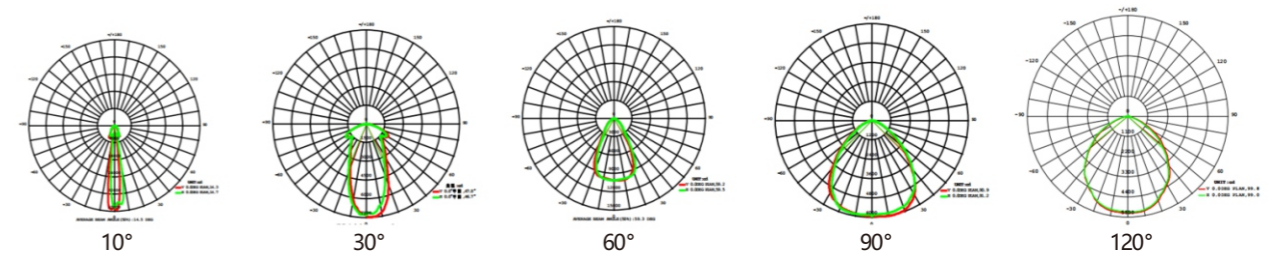

# BLACK MAMBA LED flood light

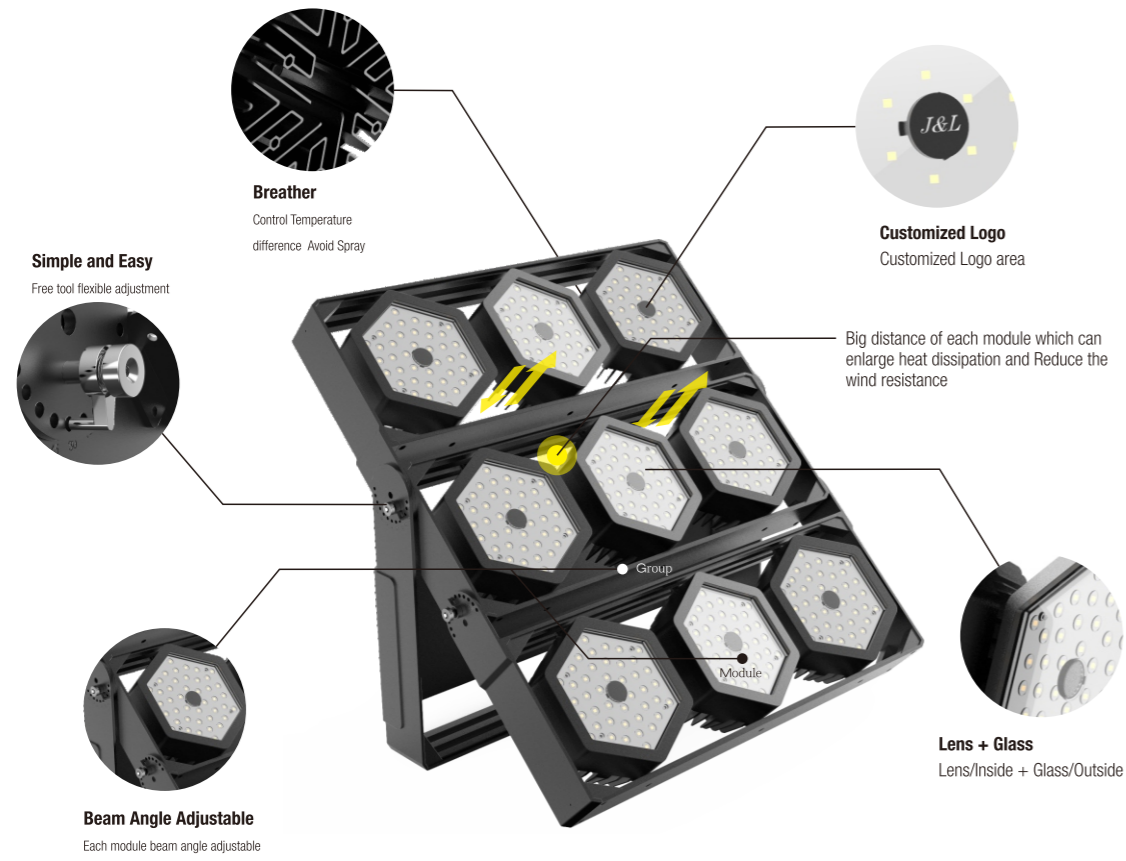

## Beam Angle

Lighting distribution can meet most of the demands for different projects

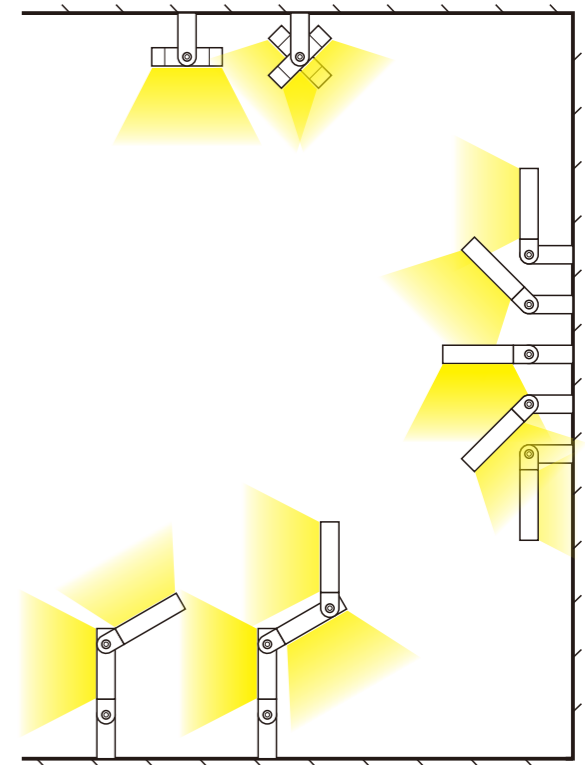
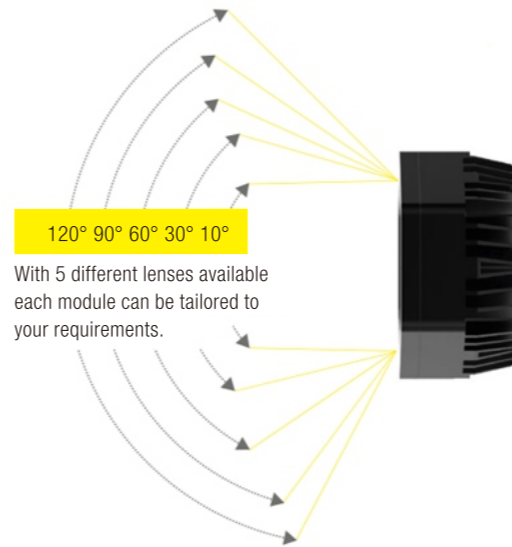

## Application

### Crosswise combination

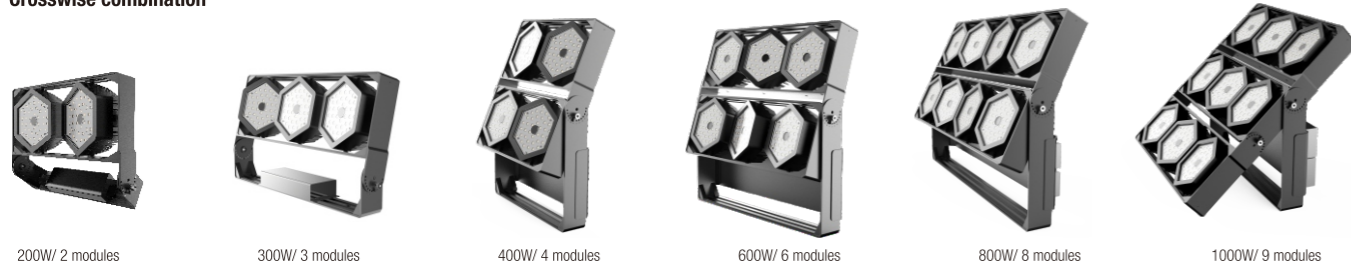

### Longitudinal combination

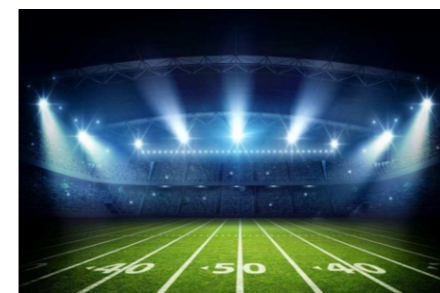

Stadium



Square

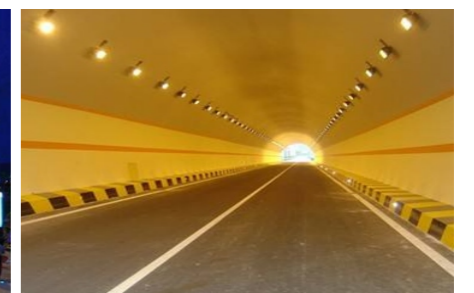

Tunnel



Bridge

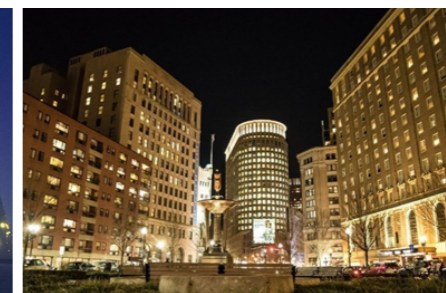

Building

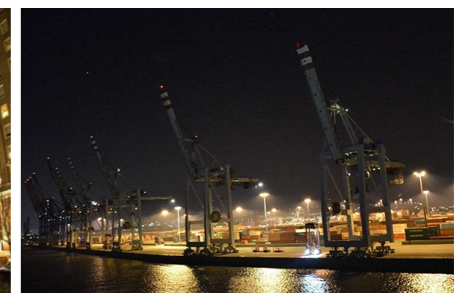

Wharf

# Small King Kong LED Floodlight



IP65

Black



## Small King Kong LED Floodlight

1. Using cold forging process molding, bigger radiating area, radiating effect.
2. High stability and color rendering
3. Old brand with quality assurance
4. IP level is high, the protective effect is better
5. Ring Bead color diversification, with a variety of selectivity
6. Non flicker, Non dazzling, High brightness.
7. Charming quality and design ,long life span
8. 3 - 5 years warranty (optional )

## Products parameter

|                                  |                                   |
|----------------------------------|-----------------------------------|
| <b>Product model / Power</b>     | FL-JL03-30W-200W                  |
| <b>Input voltage</b>             | AC85V-265V                        |
| <b>Frequency range</b>           | 50HZ-60HZ                         |
| <b>Total harmonic distortion</b> | -≤20%                             |
| <b>Lamp's efficiency</b>         | >94%                              |
| <b>Color temperature</b>         | 3000k / 4000k~4500k / 5700k~6500k |
| <b>LED Brand/Type</b>            | 2835LED                           |
| <b>LED luminous efficiency</b>   | 150LM/W                           |
| <b>Working life-span</b>         | >50,000H                          |
| <b>CRI</b>                       | ≥70                               |

# SUNMAO LED Flood Light

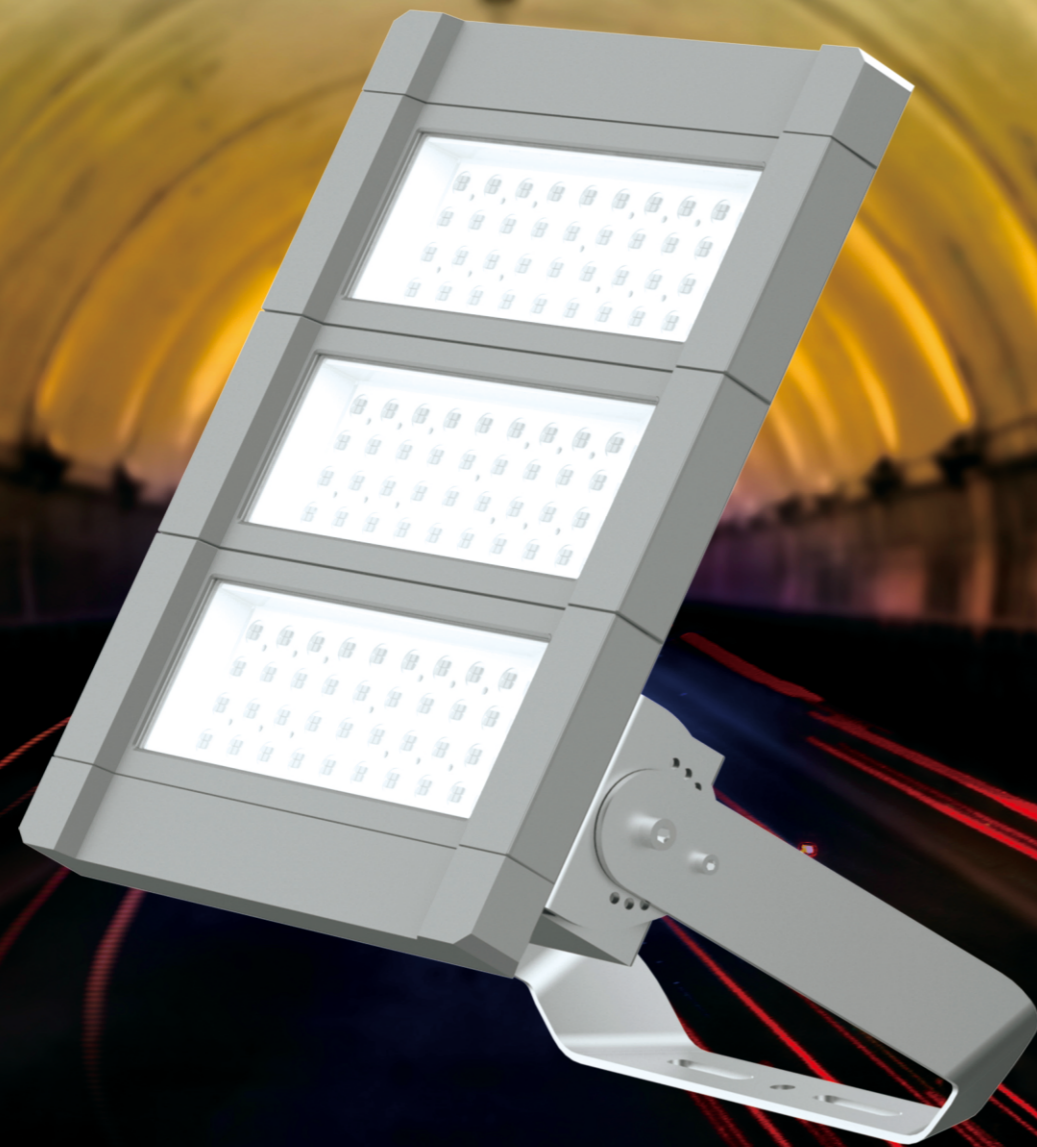

IP66 / IK08

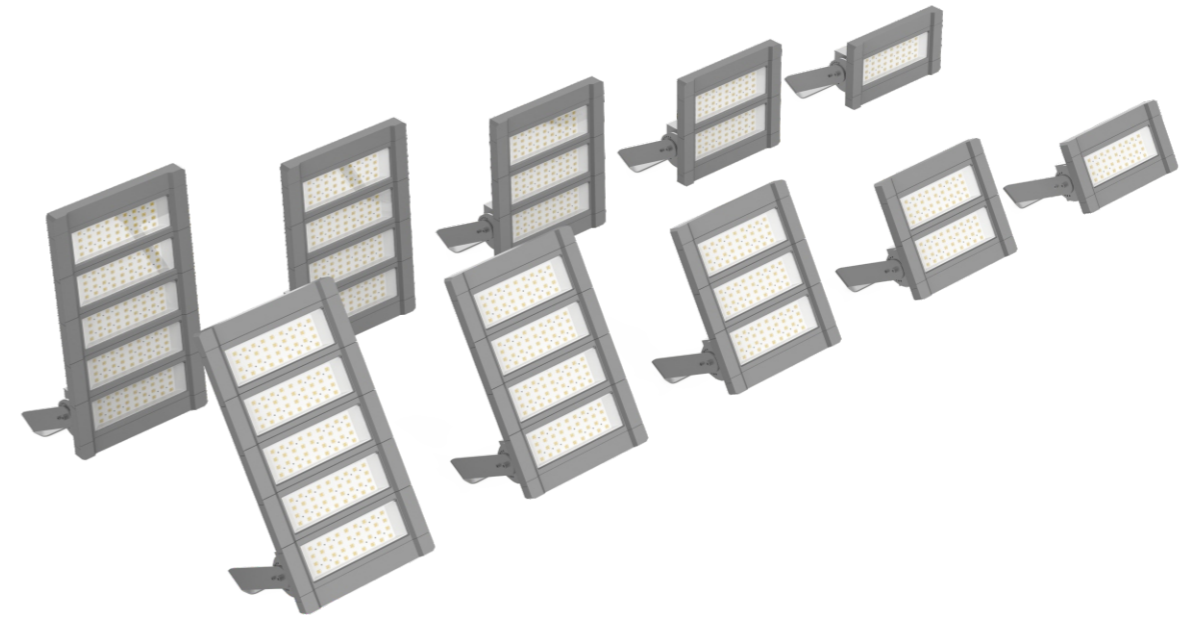

## SUNMAO LED Flood Light



1. 2019 The latest Patent design with compact and fashion appearance
2. Originate and Unique electronic connector design up to now, Easy for maintaining and replacement
3. IP66 Level protection.
4. Power from 60W up to 300W
5. Luminaire lighting efficacy 130Lm/w up to 160Lm/w
6. Patent design on straight pin led Modules. Easy assembly and maintainance
7. Long Lifespan
  - Good Heat Dissipation performance
  - Luminous SMD chips 3030 & 5050 available
  - Philips/Meanwell/Inventronics /Moso Driver available
8. Intelligentize design
  - Support installation difference intelligent controller inside
9. Customize your business
  - Laser Logo accept
  - Customized optical lens available
10. Beam angle of Lamp holder is adjustable

## SUNMAO LED flood light

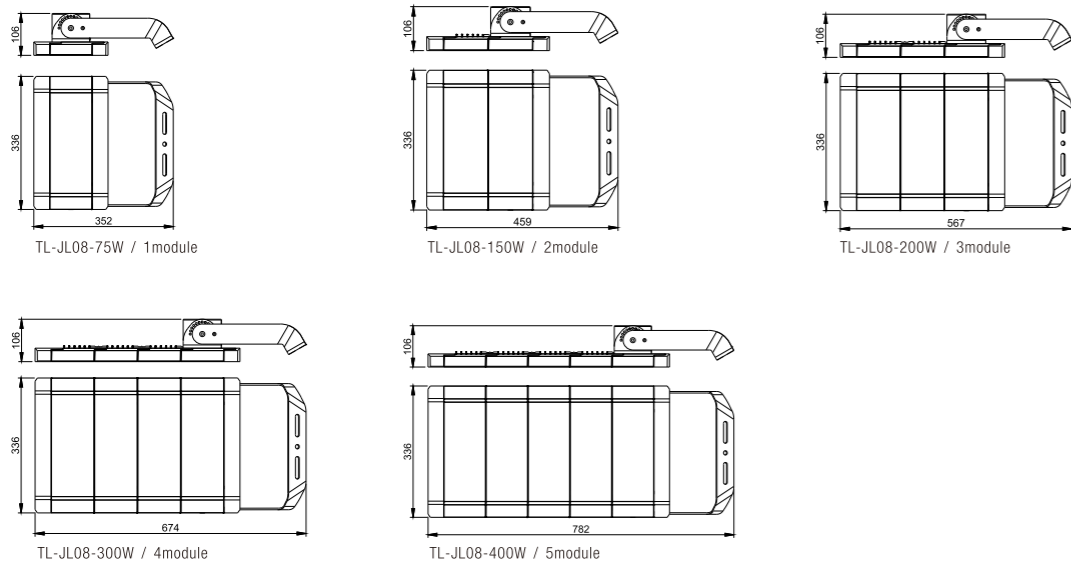

## Optical parameters

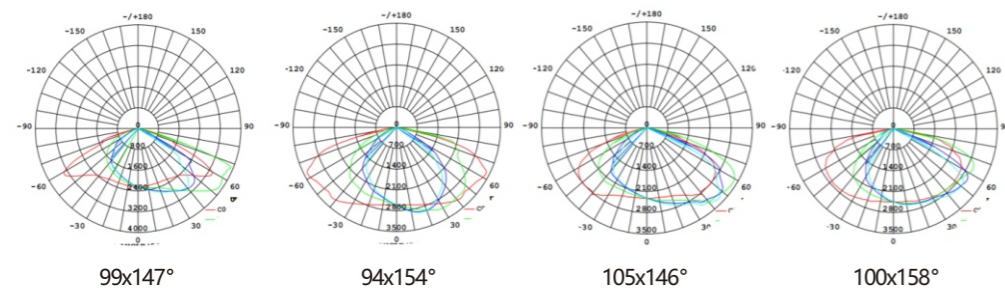

## Products parameter

|                       |  |
|-----------------------|--|
| <b>Power (+/-10%)</b> | 75W / 150W / 200W / 300W / 400W          |
| <b>Driver</b>         | Inventronics Driver                      |
| <b>Chips</b>          | PHILIPS 3030                             |
| <b>Input Voltage</b>  | AC90-305V                                |
| <b>Efficacy</b>       | 130LM/W±5%                               |
| <b>Beam angle</b>     | 99x147° / 94x154° / 105x146° / 100x158°  |
| <b>CRI</b>            | >70                                      |
| <b>CCT</b>            | 4000K/5000K                              |
| <b>Warranty</b>       | 3-5year limited system warranty standard |

# Detection capability



OPTICAL TEST

MATERIAL EXPERIMENT

## SAFETY TEST



EMC TEST

EMI TEST



ENVIRONMENTAL RELIABILITY TEST